

1

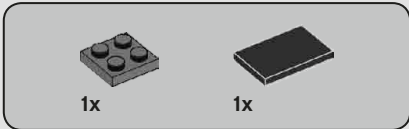

2

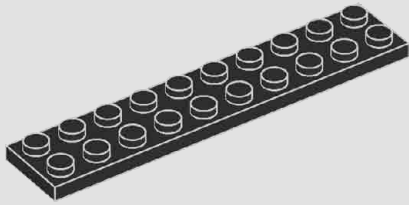
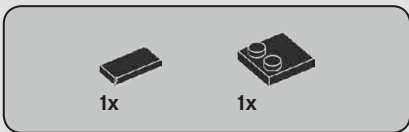
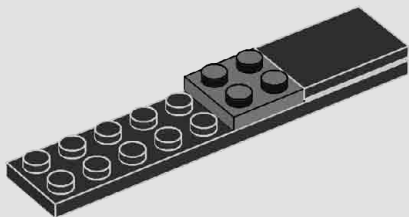

3

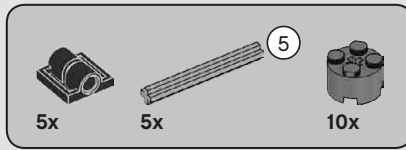
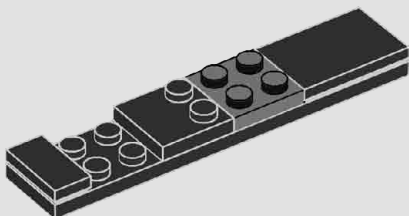

4

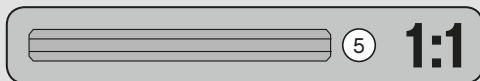
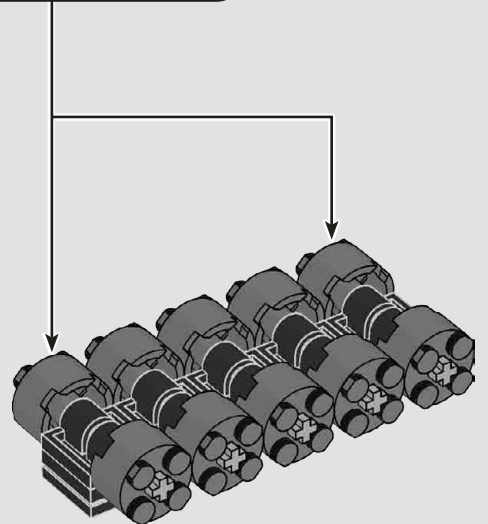
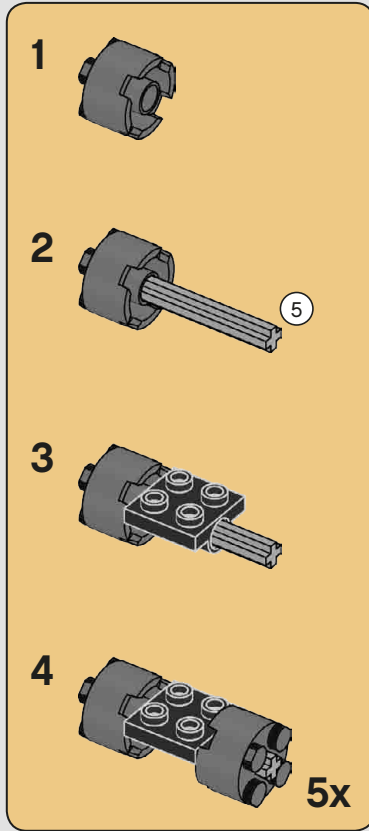

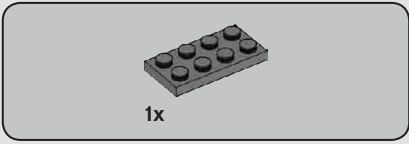
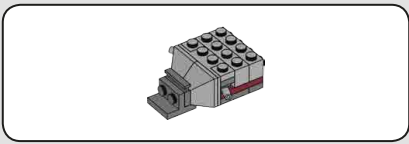

5

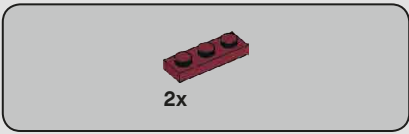
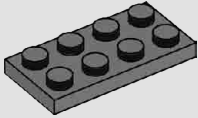

6

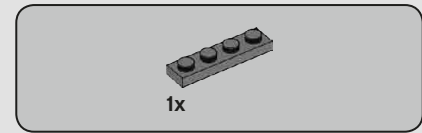
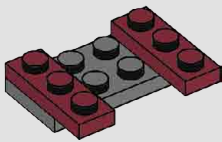

7

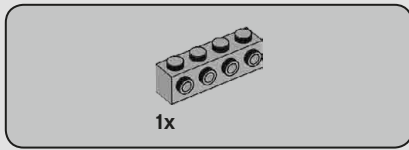
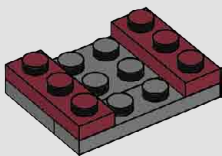

8

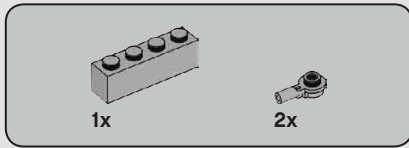
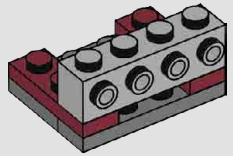

9

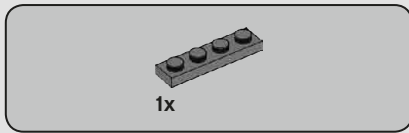
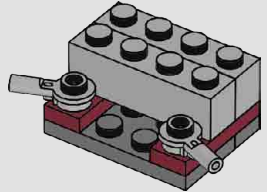

10

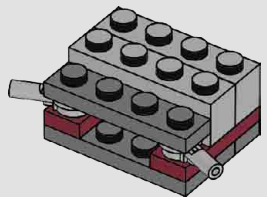



2x

11

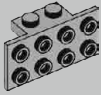
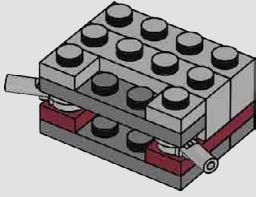

1x

12

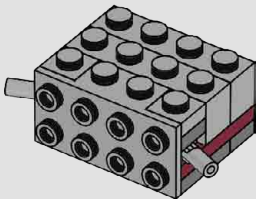

2x

13

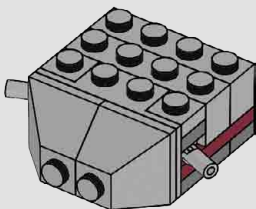

1x

14

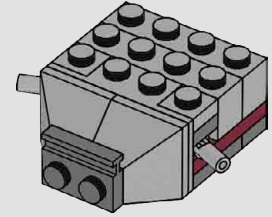

1x

15

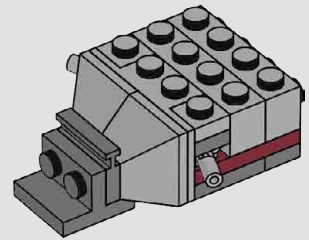

16

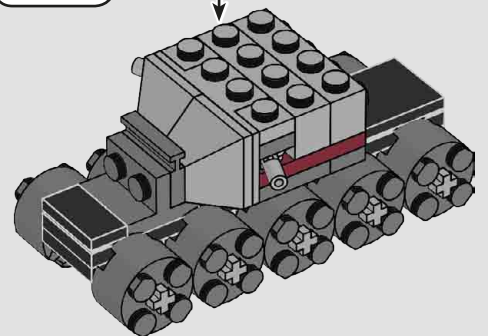

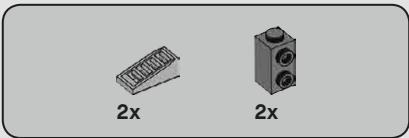

17

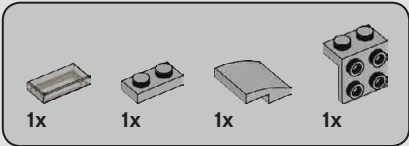
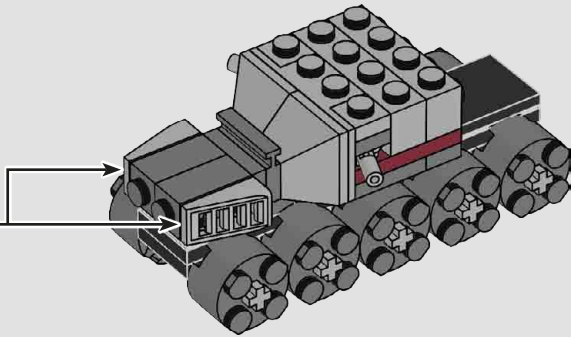
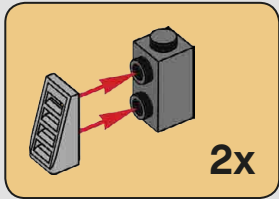

18

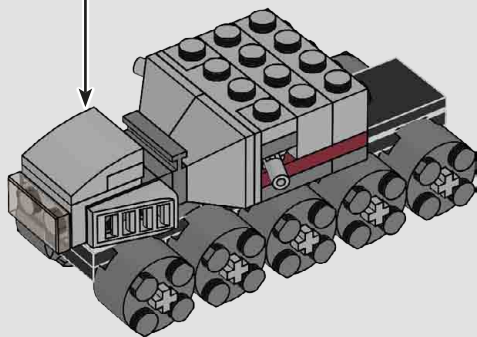
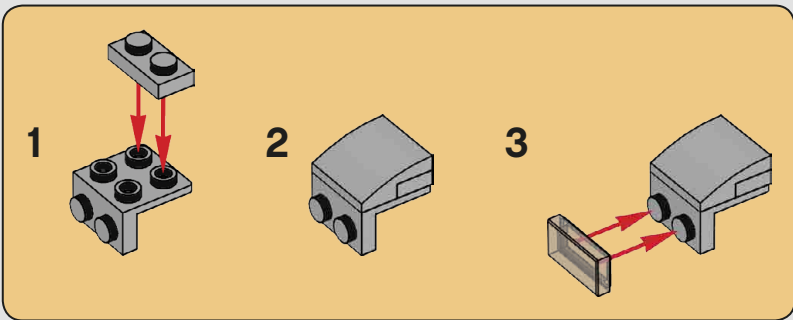

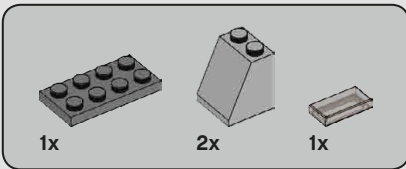

20

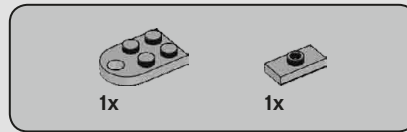
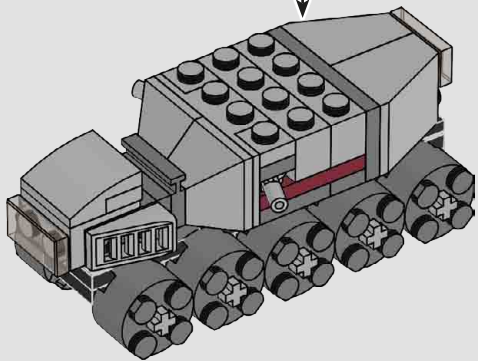
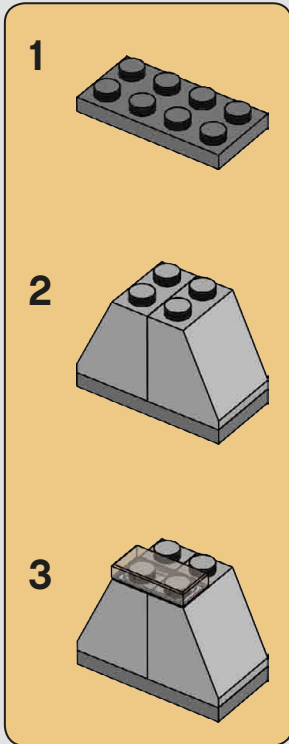

21

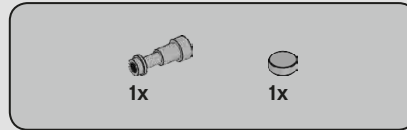
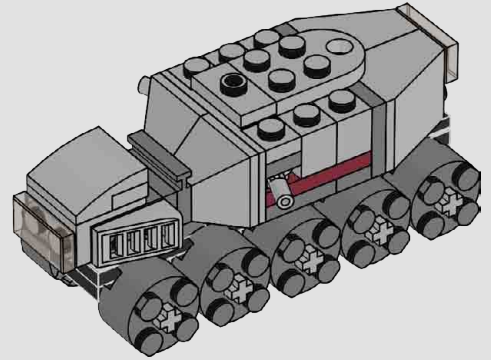

22

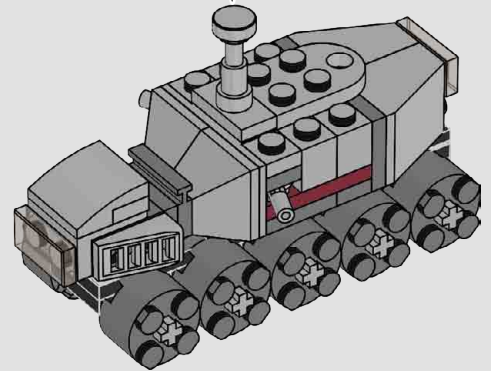
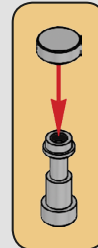



2x
6251292



1x
306926



1x
6192346



5x
281726



1x
6162892

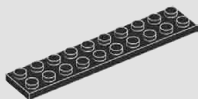

1x
383226



2x
4539076



1x
6284071



2x
4211399



2x
6227897



1x
4211398



2x
6092111



1x
6066097



1x
4657366



1x
6117967



1x
6102357



2x
4234535



2x
4216250



1x
4211636



1x
4211419



1x
6118827



1x
4211394

5

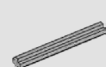

5x
4211639



2x
6228923



10x
4249139



1x
6250018



1x
4543086



1x
4211094



2x
4211001



2x
4211065